

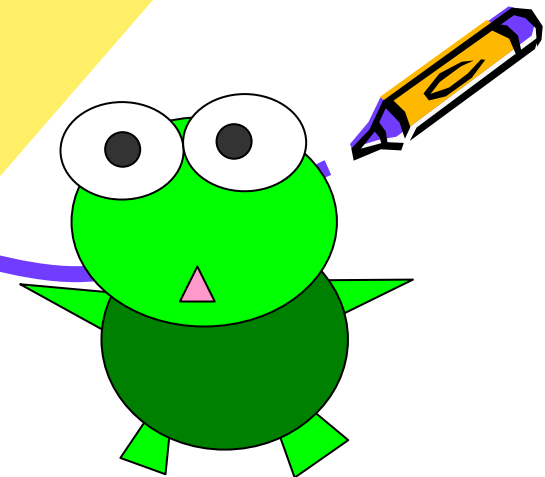

いえ つく
つよい家を作ろう！
しんぶんし
新聞紙となかよくする家
いえ

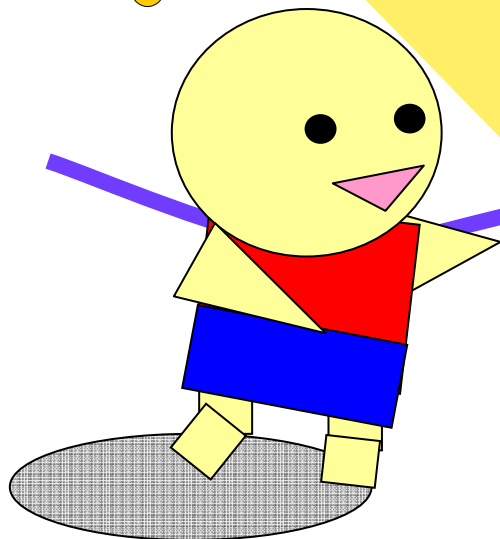
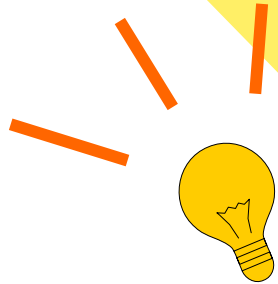

クイズ

どっちが強い??
つよ

さんかくけいのもけい

① 三角の模型

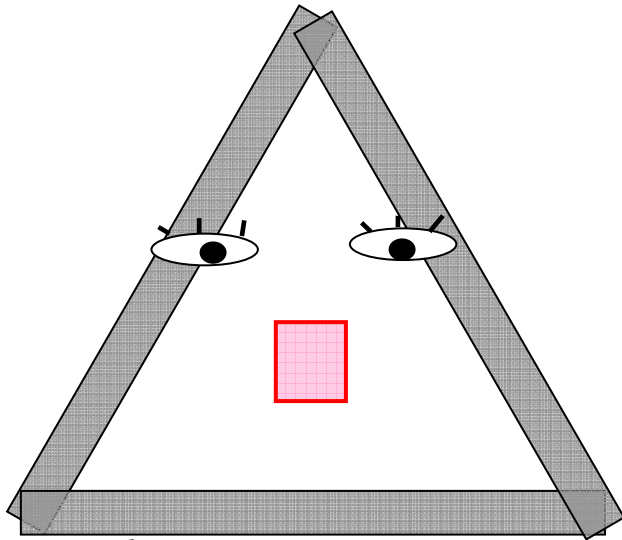

しかくけいのもけい

② 四角形の模型

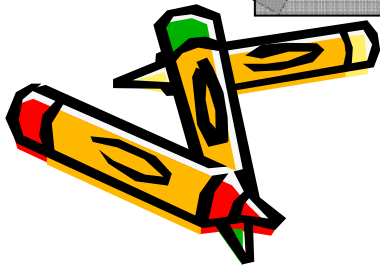
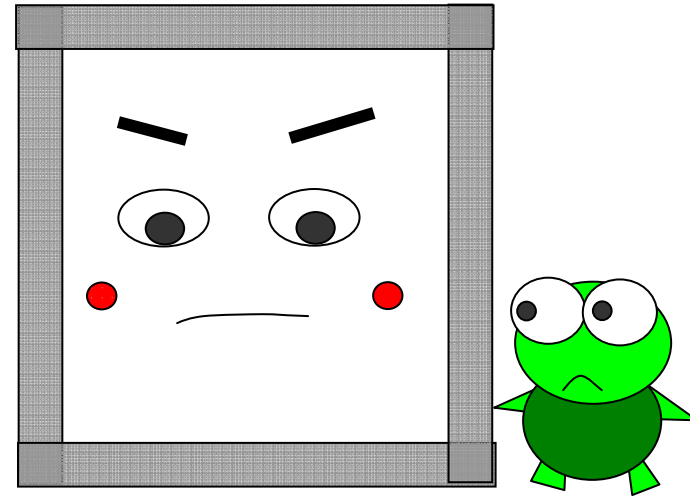

じっさいにためしてみよう！

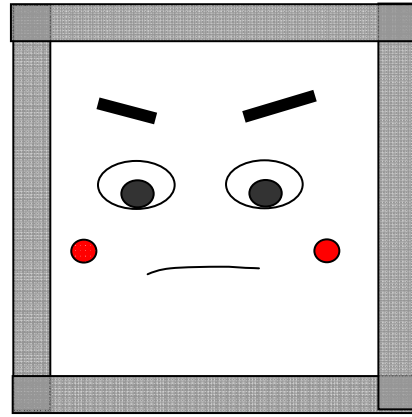
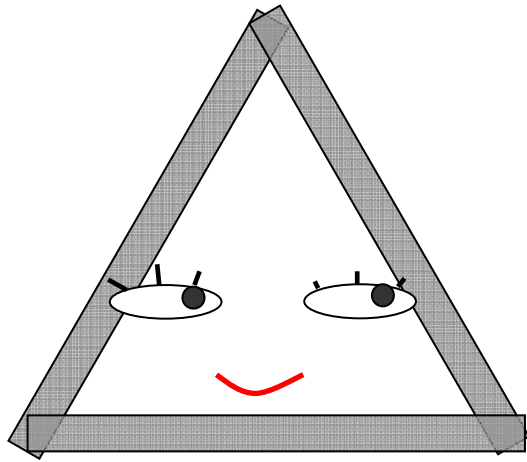

まえにあつまれー

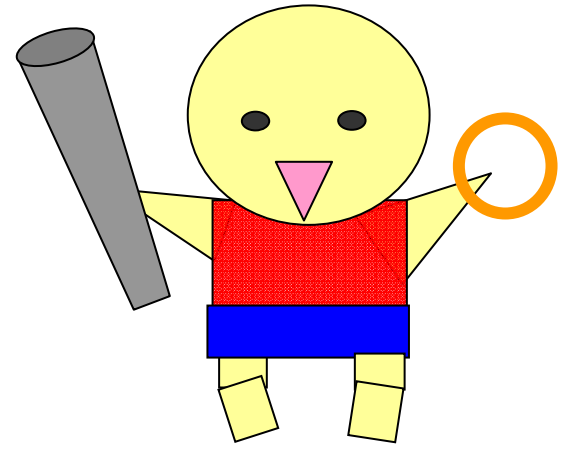

ゆらしてみよう！

どっちが強いかな？
つよ

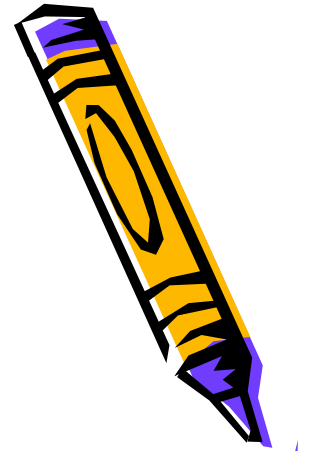
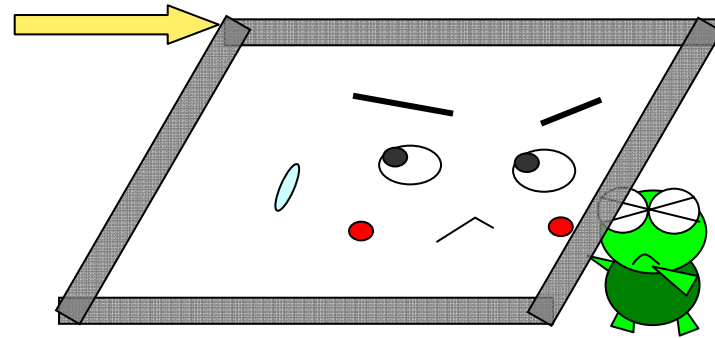
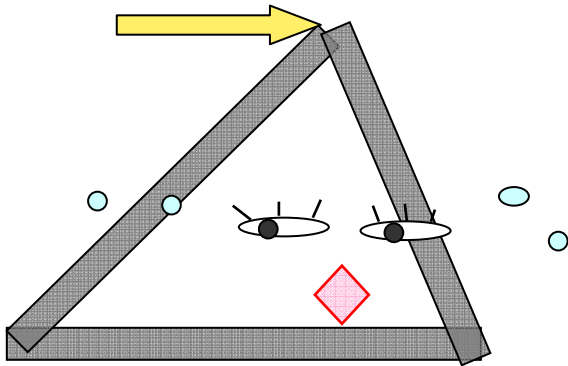

けっか
結果

しかくけい
四角形

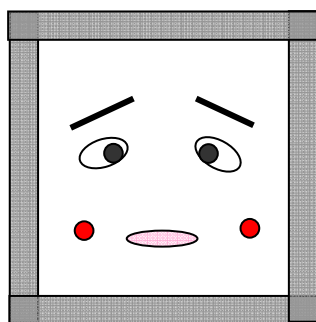

より

さんかくけい
三角形

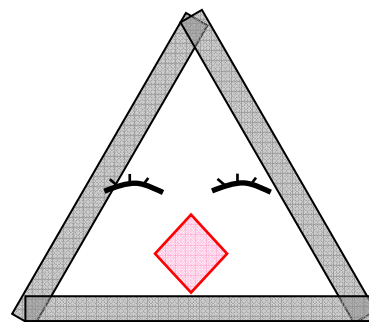

のほうがつよかった！



さんかくけい
つよかった三角形をつかって

かたち
テントの形をつくってみよう☆

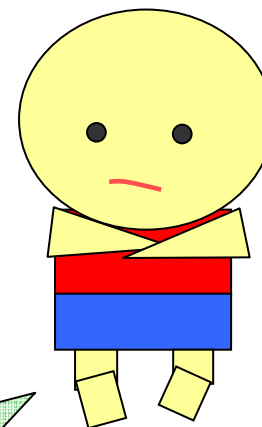
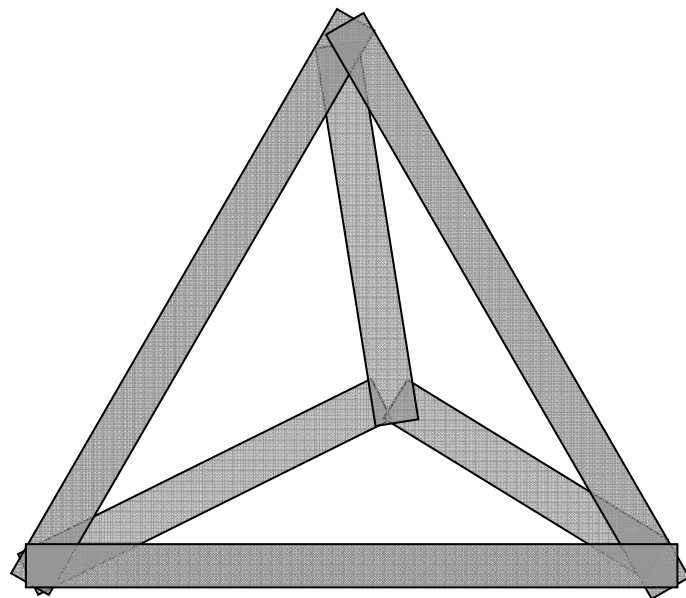

どうやったら
うまく作れるかな？



こうぞう
とってもつよい構造ができた！

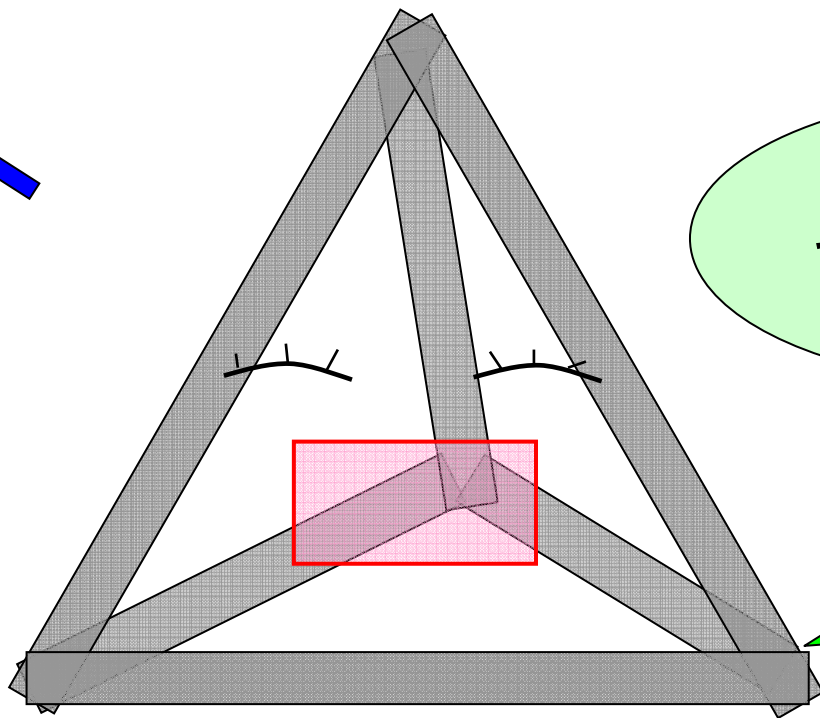
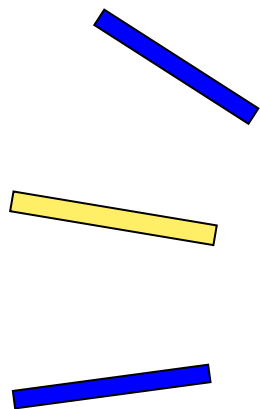

ゆらされたって
びくもしないよ

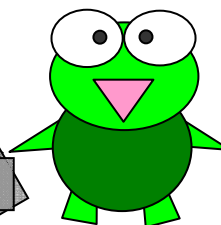

しかく
じゃあ、四角はダメなの？

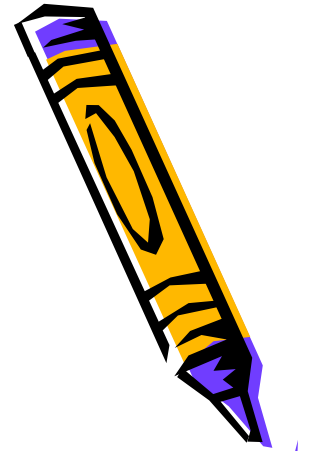

?? ? ? ? ? ? ? ? ?

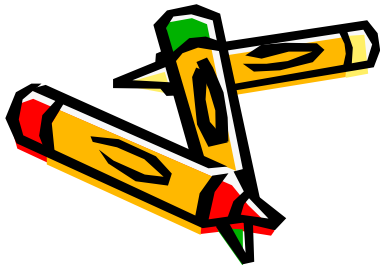
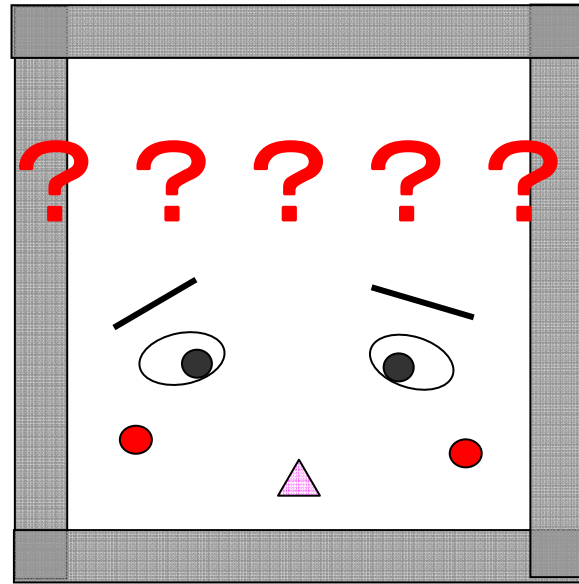

クイズ

しかく

四角がつよくなるのはどれ？

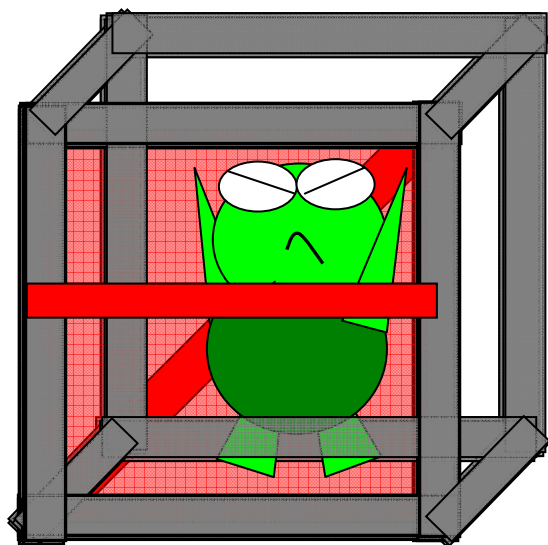

③ ^{ぼう ぼう}かたえのく棒棒が
④ ^{ぼう ぼう}かたえのく棒棒が
② ^{ぼう ぼう}かたえのく棒棒が
① ^{ぼう ぼう}かたえのく棒棒が



どれがいいかな??

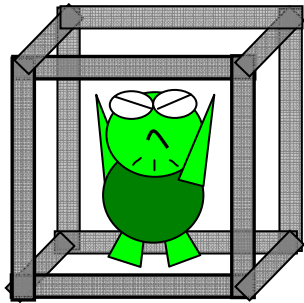

①
かえるくんが
した
下からささえる。

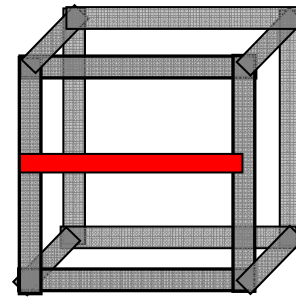

②
ぼう
よこに棒を
入れる。

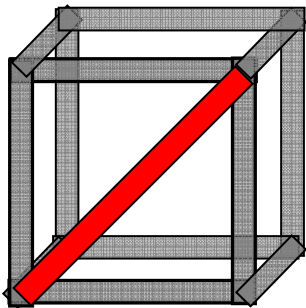

③
ななめに
ぼう
棒を入れる。

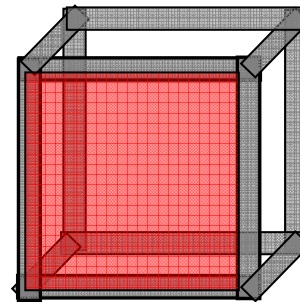

④
い
かべを入れる。

正解は

③

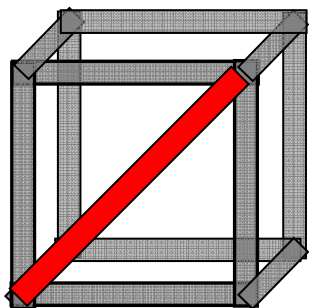

と

④

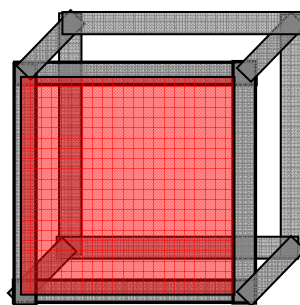

でしたー。

ぼくじゃダメ
だったー。

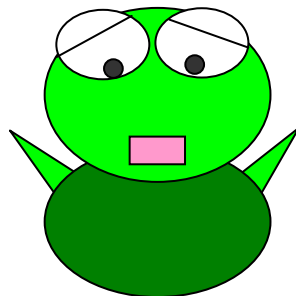

なな ぼう
じっさいに斜めの棒
をいれてみよう。

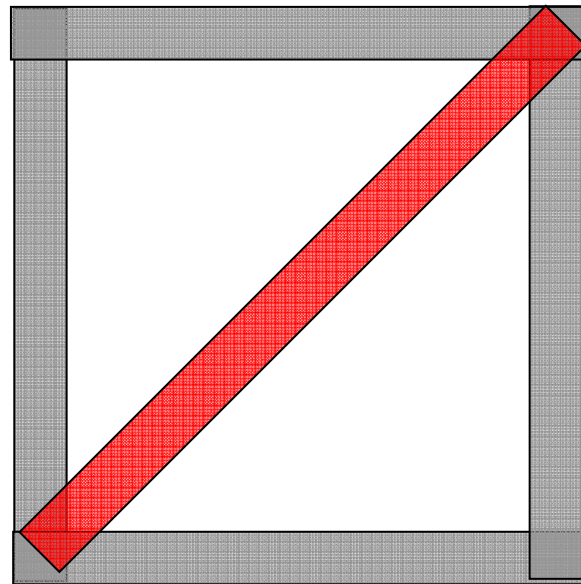

すじ
筋かいて
言うんだよ

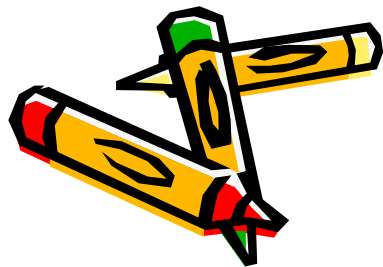
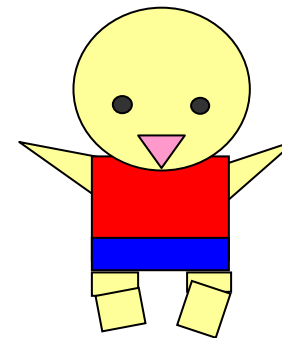

しかく
四角でもつよくなった！！

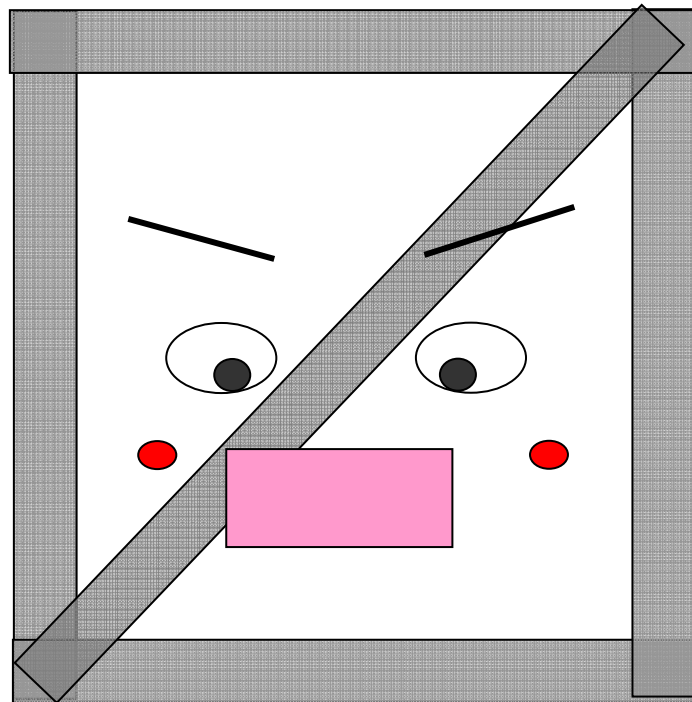

これからは
ゆらされても、
へっちゃらさ

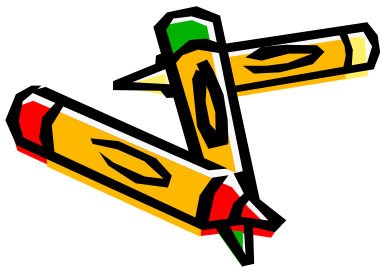

かべをいれてみよう！！

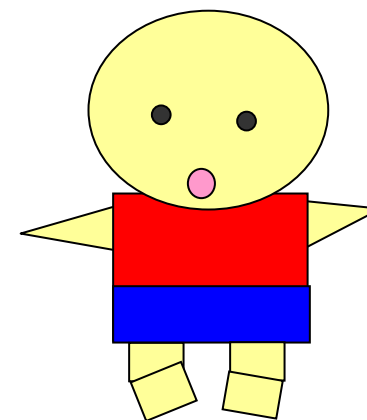
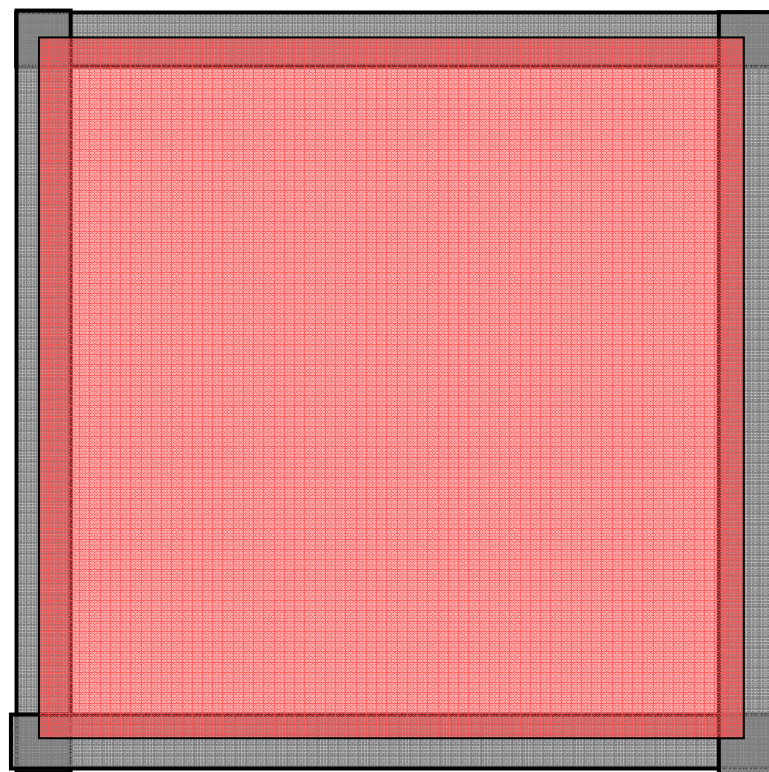

ゆらしてもへっちらだよ。

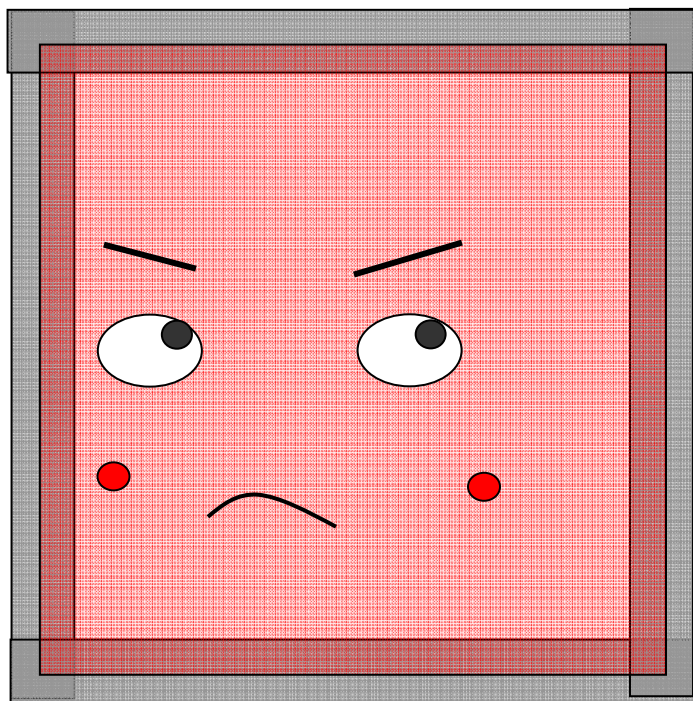

つよ
強い



こんどは^{さんかく}三角と^{しかく}四角を^く組み^{あわ}合わせ
^{いえ}つよい^{つく}家を作ってみよう！



ゆらしても
へいきかな？

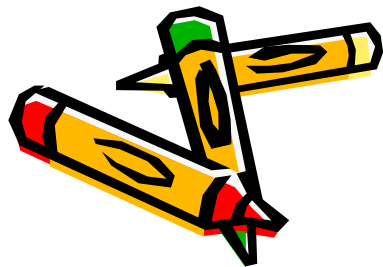
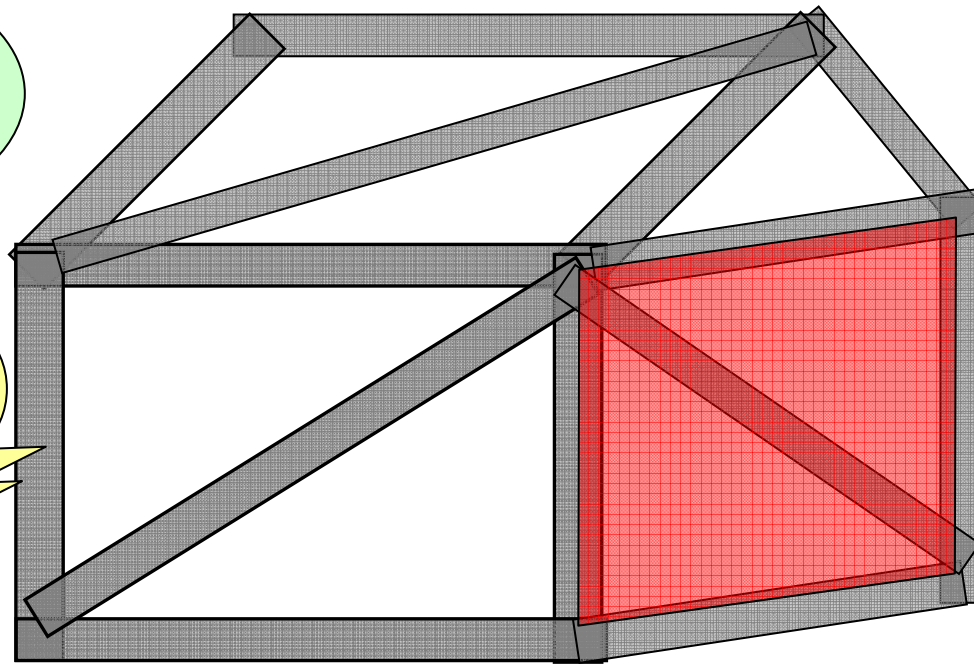
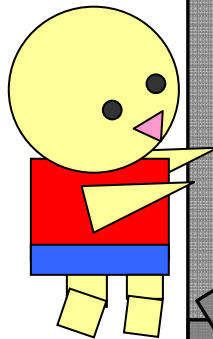

いえ
つよい家が
かんせいしたね。

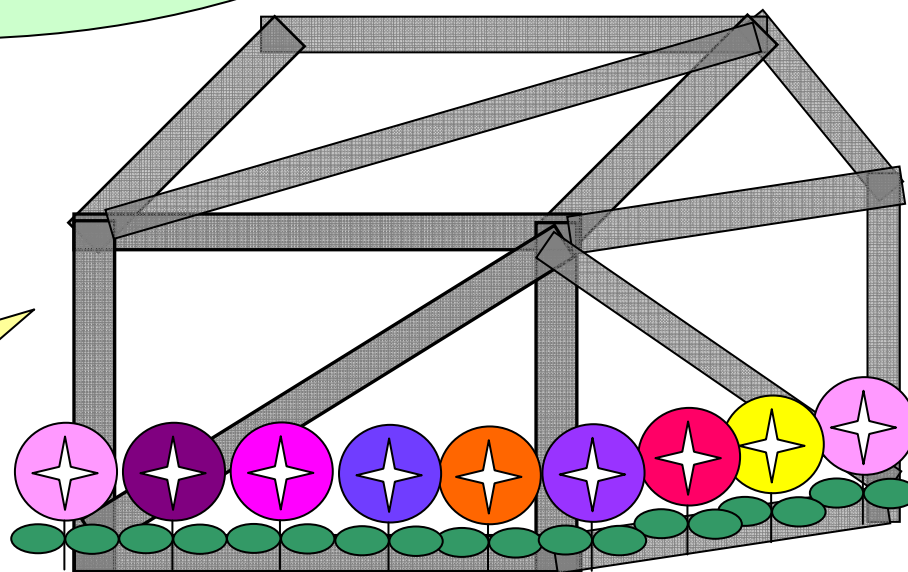
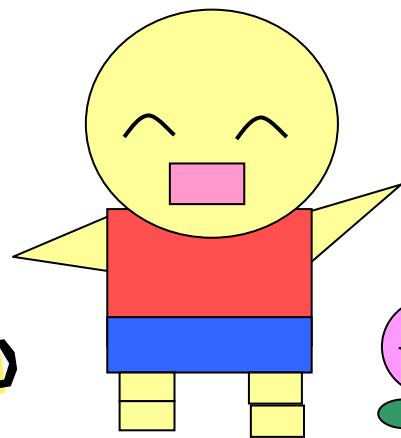

いえ
ほかのつよい家を
しょうかい
紹介するよ

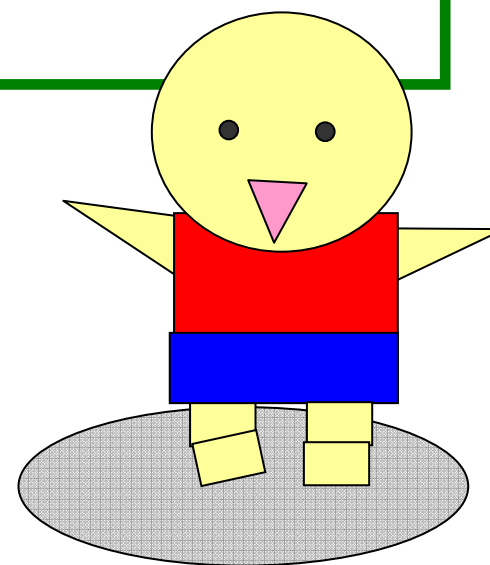
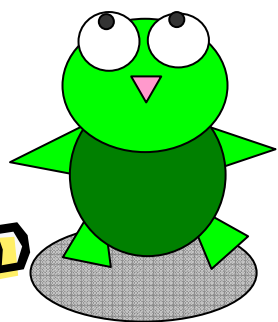

新聞紙を#げたにつむよ。

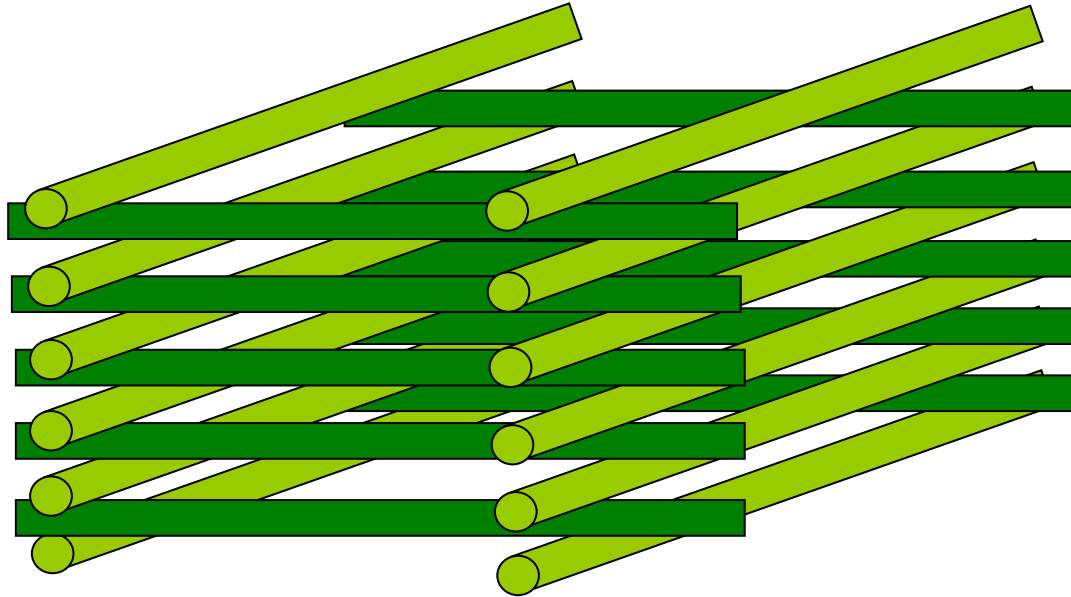
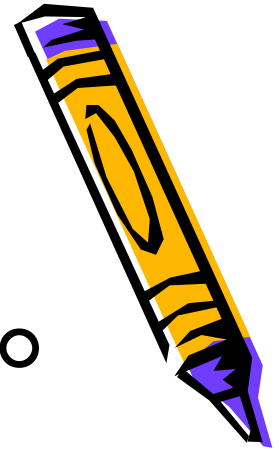

ていねい
にね

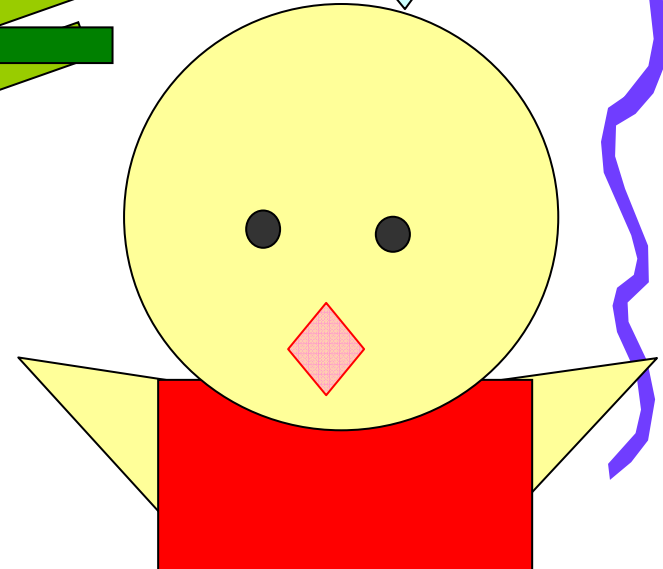

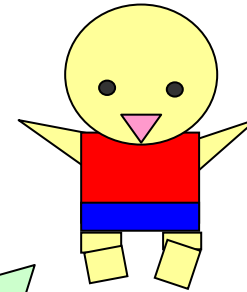
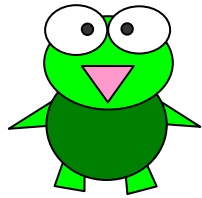
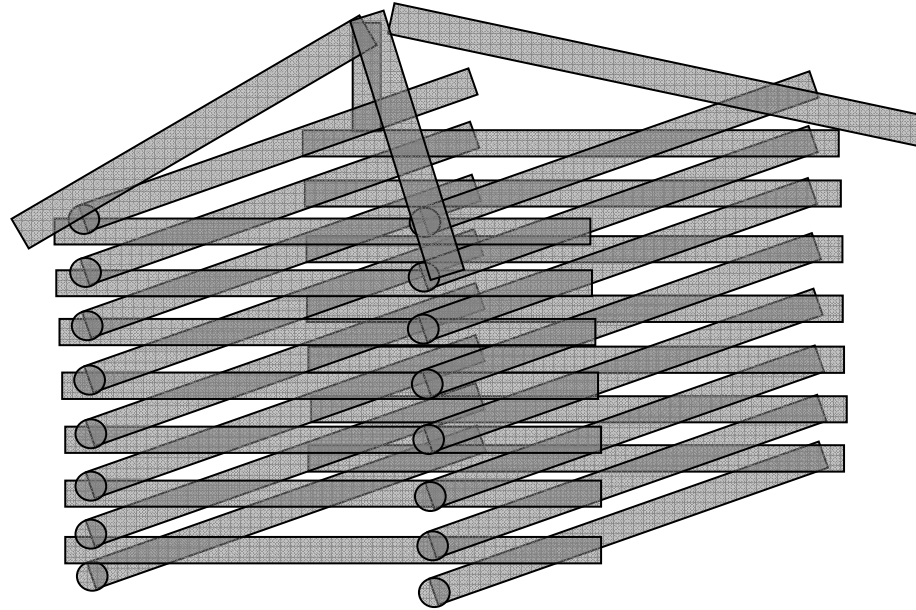

こんな家もできるよ。



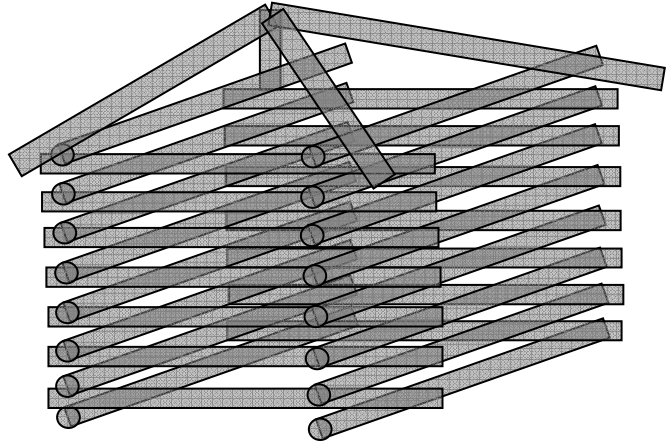

や

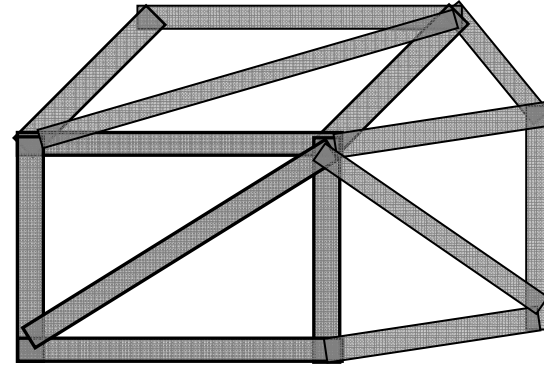

しんぶんし じょうぶ もけい
など新聞紙で丈夫な模型ができたね。

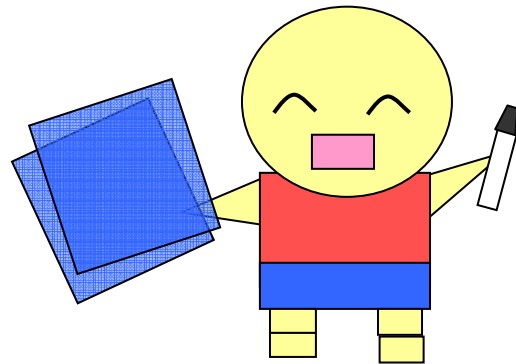
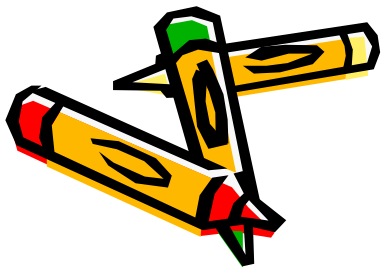

セロファンやペンを
つかっているいろ
いろ
工夫してみよう！